



# HER501 THRU HER508

## HIGH EFFICIENT SILICON RECTIFIER

Reverse Voltage - 50 to 1000 Volts      Forward Current - 5.0 Ampere

### FEATURES

- The plastic package carries Underwriters Laboratory Flammability Classification 94V-0
- Ultra fast switching for high efficiency
- Low reverse leakage
- High forward surge current capability
- High temperature soldering guaranteed:  
250°C/10 seconds, 0.375" (9.5mm) lead length, 5 lbs. (2.3kg) tension

### MECHANICAL DATA

**Case:** JEDEC DO-201AD molded plastic body  
**Terminals:** Plated axial leads, solderable per MIL-STD-750, Method 2026  
**Polarity:** Color band denotes cathode end  
**Mounting Position:** Any  
**Weight:** 0.04 ounce, 1.10 grams

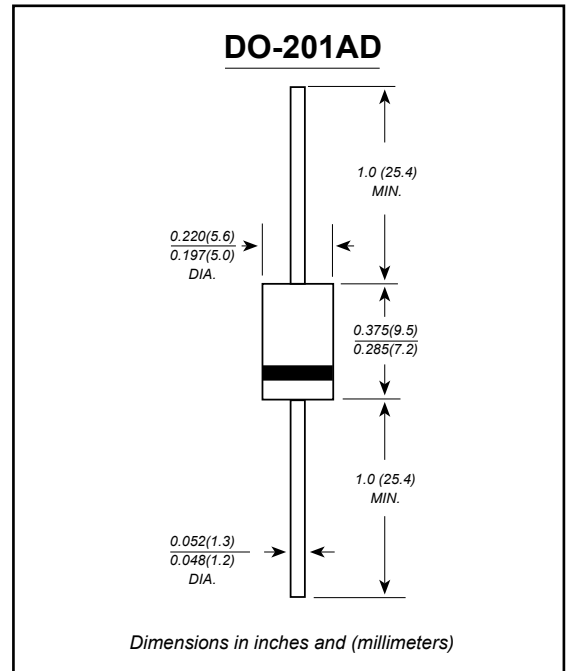

### MAXIMUM RATINGS AND ELECTRICAL CHARACTERISTICS

Ratings at 25°C ambient temperature unless otherwise specified.  
 Single phase half-wave 60Hz, resistive or inductive load, for capacitive load current derate by 20%.

Characteristic	Symbol	HER 501	HER 502	HER 503	HER 504	HER 505	HER 506	HER 507	HER 508	Unit	
Peak Repetitive Reverse Voltage	V <sub>RRM</sub>	50	100	200	300	400	600	800	1000	V	
Working Peak Reverse Voltage	V <sub>RWM</sub>										
DC Blocking Voltage	V <sub>R</sub>										
RMS Reverse Voltage	V <sub>R(RMS)</sub>	35	70	140	210	280	420	560	700	V	
Average Rectified Output Current (Note 1) @T <sub>A</sub> = 55°C	I <sub>O</sub>	5.0								A	
Non-Repetitive Peak Forward Surge Current 8.3ms Single half sine-wave superimposed on rated load (JEDEC Method)	I <sub>FSM</sub>	150								A	
Forward Voltage @I <sub>F</sub> = 5.0A	V <sub>FM</sub>	1.0			1.3		1.7			V	
Peak Reverse Current @T <sub>A</sub> = 25°C At Rated DC Blocking Voltage @T <sub>A</sub> = 100°C	I <sub>RM</sub>	10 100								µA	
Reverse Recovery Time (Note 2)	t <sub>rr</sub>	50					75				nS
Typical Junction Capacitance (Note 3)	C <sub>j</sub>	75					50				pF
Operating Temperature Range	T <sub>j</sub>	-65 to +150								°C	
Storage Temperature Range	T <sub>STG</sub>	-65 to +150								°C	

- Note: 1. Leads maintained at ambient temperature at a distance of 9.5mm from the case  
 2. Measured with I<sub>F</sub> = 0.5A, I<sub>R</sub> = 1.0A, I<sub>RR</sub> = 0.25A. See figure 5.  
 3. Measured at 1.0 MHz and applied reverse voltage of 4.0V D.C.



# HER501 THRU HER508

## RATINGS AND CHARACTERISTIC CURVES

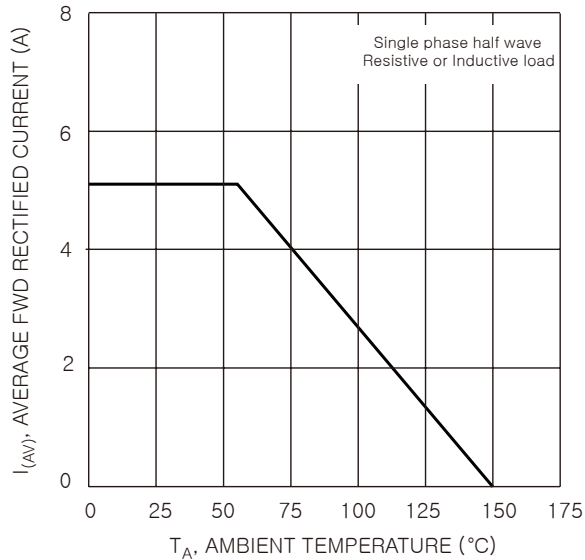

Fig. 1 Forward Current Derating Curve

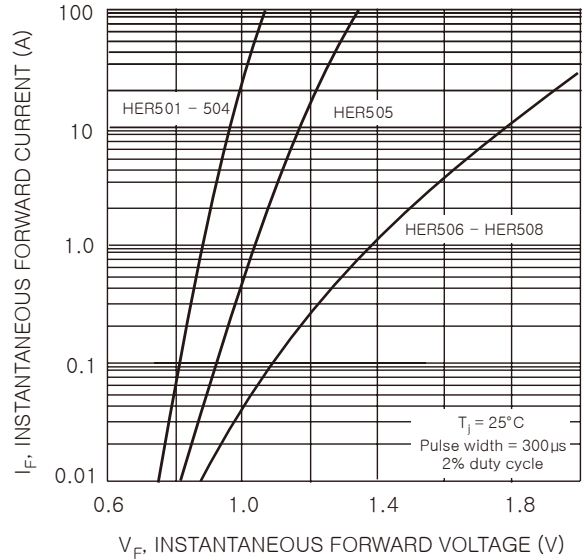

Fig. 2 Typical Forward Characteristics

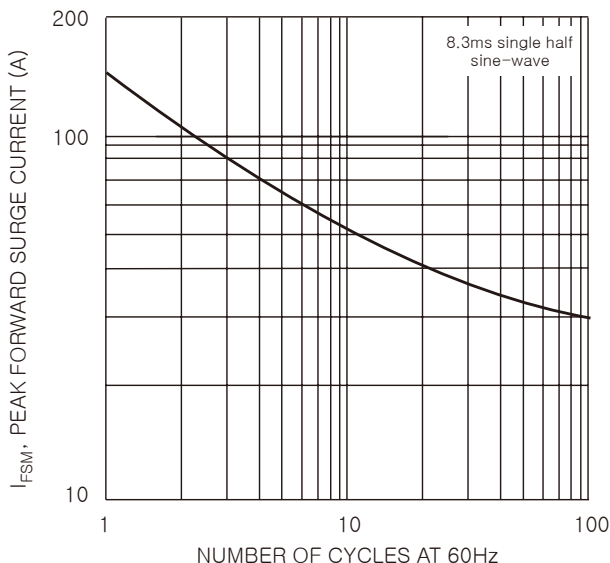

Fig. 3 Peak Forward Surge Current

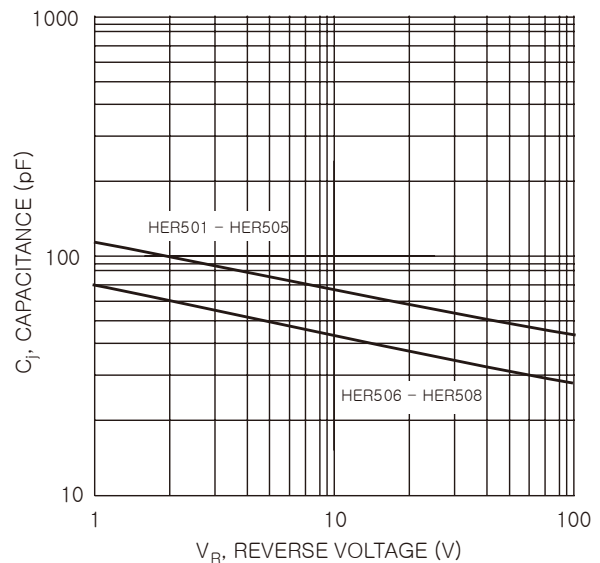
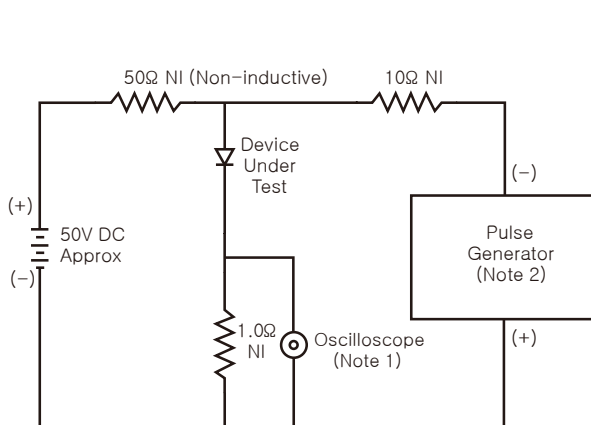

Fig. 4 Typical Junction Capacitance



Notes:

1. Rise Time = 7.0ns max. Input Impedance = 1.0M $\Omega$ , 22pF.
2. Rise Time = 10ns max. Input Impedance = 50 $\Omega$ .

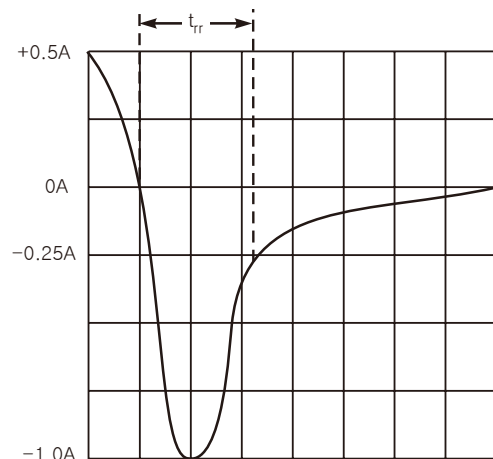

Fig. 5 Reverse Recovery Time Characteristic and Test Circuit