



ES2AA THRU ES2JA

SURFACE MOUNT SUPER FAST RECTIFIER

Reverse Voltage - 50 to 600 Volts Forward Current - 2.0 Ampere

FEATURES

- The plastic package carries Underwriters Laboratory Flammability Classification 94V-0
- For surface mounted applications
- Super fast switching for high efficiency
- Low reverse leakage
- Built-in strain relief, ideal for automated placement
- High forward surge current capability
- High temperature soldering guaranteed:
250 °C/10 seconds at terminals

MECHANICAL DATA

Case: JEDEC DO-214AC molded plastic body

Terminals: Solder plated, solderable per MIL-STD-750, Method 2026

Polarity: Color band denotes cathode end

Mounting Position: Any

Weight: 0.003 ounce, 0.093 grams

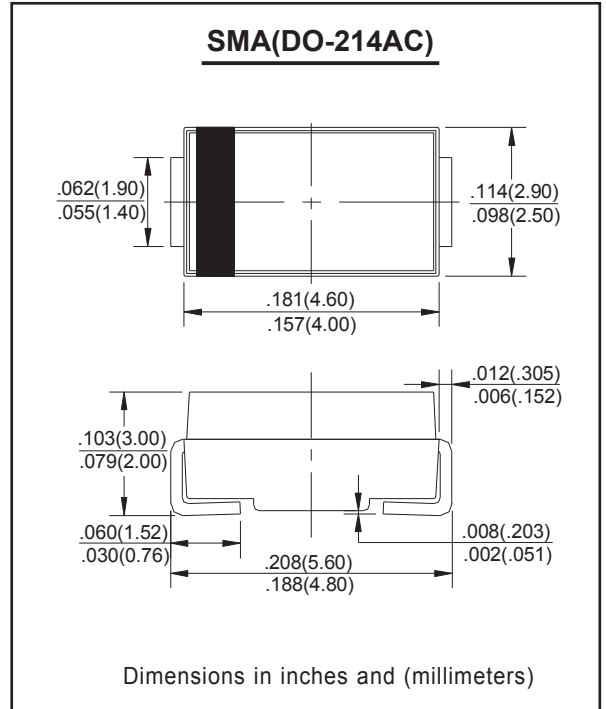

MAXIMUM RATINGS AND ELECTRICAL CHARACTERISTICS

Ratings at 25°C ambient temperature unless otherwise specified.

Single phase half-wave 60Hz, resistive or inductive load, for capacitive load current derate by 20%.

Characteristic	Symbol	ES2AA	ES2BA	ES2CA	ES2DA	ES2EA	ES2GA	ES2JA	Unit	
Peak Repetitive Reverse Voltage	VRRM									
Working Peak Reverse Voltage	VRWM	50	100	150	200	300	400	600	V	
DC Blocking Voltage	VR									
RMS Reverse Voltage	VR(RMS)	35	70	105	140	210	280	420	V	
Average Rectified Output Current @T _C = 100°C	I _O	2.0								A
Non-Repetitive Peak Forward Surge Current 8.3ms Single half sine-wave superimposed on rated load (JEDEC Method)	I _{FSM}	50								A
Forward Voltage @I _F = 2.0A	V _{FM}	0.95			1.3		1.7		V	
Peak Reverse Current @T _A = 25°C	I _{RM}	10							μA	
At Rated DC Blocking Voltage @T _A = 100°C		350								
Reverse Recovery Time (Note 1)	t _{rr}	35							nS	
Typical Junction Capacitance (Note 2)	C _j	25				20				pF
Operating and Storage Temperature Range	T _j , T _{STG}	-55 to +150							°C	

Note: 1. Measured with I_F = 0.5A, I_R = 1.0A, I_{RR} = 0.25A.

2. Measured at 1.0 MHz and applied reverse voltage of 4.0V D.C.



ES2AA THRU ES2JA

RATINGS AND CHARACTERISTIC CURVES

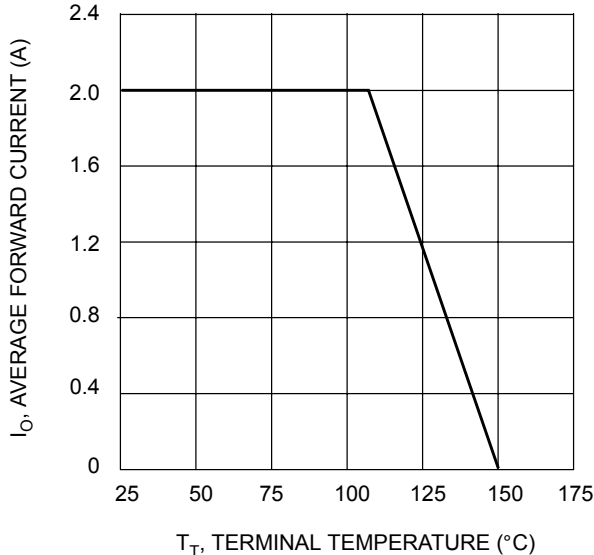

Fig. 1 Forward Current Derating Curve

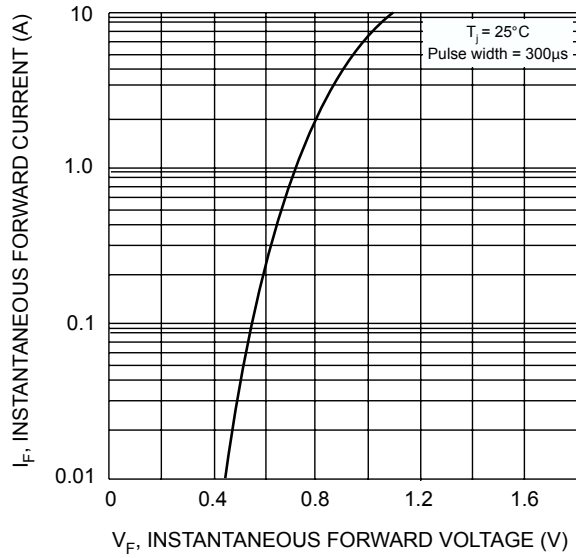

Fig. 2 Typical Forward Characteristics

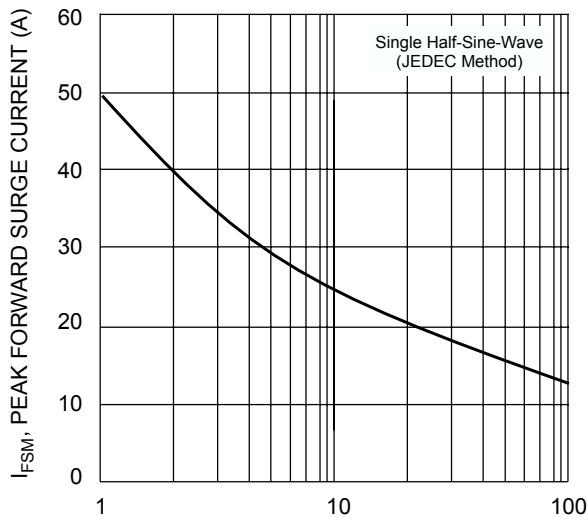

Fig. 3 Surge Current Derating Curve

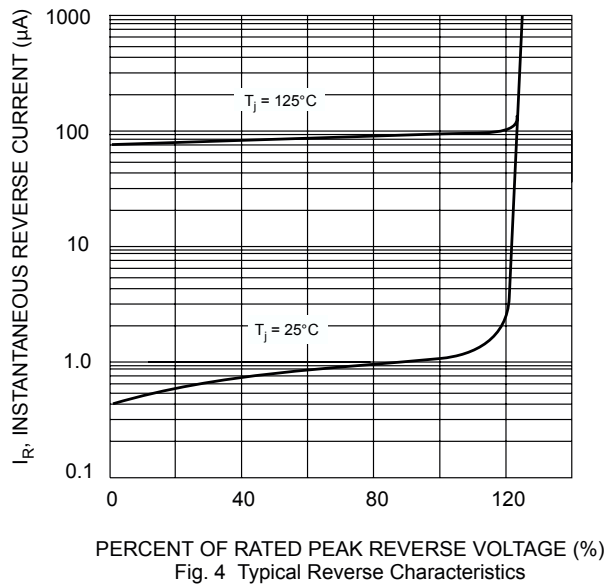
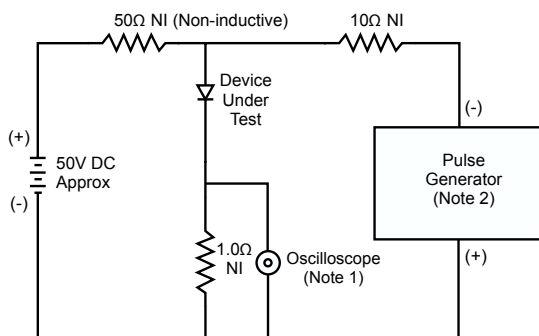
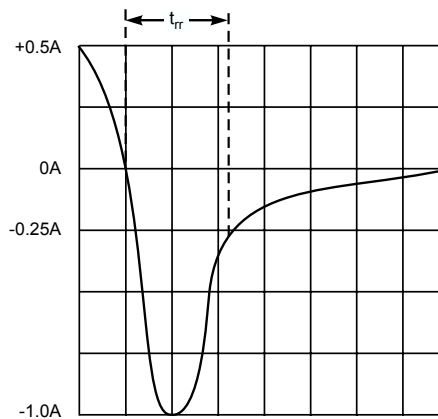

Fig. 4 Typical Reverse Characteristics



- Notes:
1. Rise Time = 7.0ns max. Input Impedance = 1.0M Ω , 22pF.
 2. Rise Time = 10ns max. Input Impedance = 50 Ω .



Set time base for 50/100 ns/cm

Fig. 5 Reverse Recovery Time Characteristic and Test Circuit