



BZT52C2V4 ~ BZT52C51

SURFACE MOUNT ZENER DIODE

Features

- Planar Die Construction
- 500mW Power Dissipation on Ceramic PCB
- General Purpose, Medium Current
- Ideally Suited for Automated Assembly Processes

Mechanical Data

- Case: SOD-123, Plastic
- UL Flammability Classification Rating 94V-0
- Moisture Sensitivity: Level 1 per J-STD-020A
- Terminals: Solderable per MIL-STD-202, Method 208
- Polarity: Cathode Band
- Marking: See Below
- Weight: 0.01 grams (approx.)

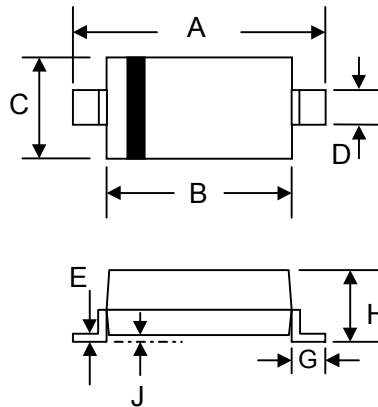

SOD-123		
Dim	Min	Max
A	3.6	3.9
B	2.5	2.8
C	1.4	1.8
D	0.5	0.7
E	—	0.2
G	0.4	—
H	0.95	1.35
J	—	0.12
All Dimensions in mm		

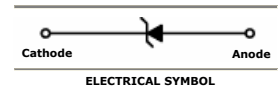

Maximum Ratings @ $T_A=25^{\circ}\text{C}$ unless otherwise specified

Type Number	Symbol	Value	Units
Forward Voltage @ $I_F = 10\text{mA}$	V_F	0.9	V
Power Dissipation (Note 1)	P_d	500	mW
Thermal Resistance Junction to Ambient Air (Note 1)	$R_{\theta JA}$	305	$^{\circ}\text{C/W}$
Operating and Storage Temperature Range	T_J, T_{STG}	-55 to + 150	$^{\circ}\text{C}$

- Notes:
1. Device Mounted on Ceramic PCB, 7.6mm x 9.4mm x 0.87mm with Pad Areas 25mm².
 2. Tested with Pulses. Period = 5ms, Pulse Width = 300us.
 3. When Provided, Otherwise, Parts are Provided with Date Code only, and Type Number Identifications Appears on reel only.
 4. $f = 1\text{KHz}$.

Marking Information

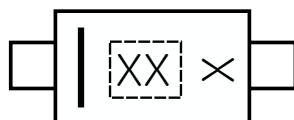

XX = Product Type Marking Code (See Page 2)
X = Date Code Marking



BZT52C2V4 ~ BZT52C51

SURFACE MOUNT ZENER DIODE

Electrical Characteristics ($T_A=25^\circ\text{C}$ unless otherwise noted, $V_F=0.9\text{V Max@ } I_F=10\text{mA}$)

Device	Device Marking (2)	Zener Voltage Range (1)				Maximum Zener Impedance(3)			Maximum Reverse Current		Typical Temperature Coefficient @ I_{ZT} mV/°C		Test Current I_{ZTC} mA
		$V_Z @ I_{ZT}$			@ I_{ZT}	$Z_{ZT} @ I_{ZT}$	$Z_{ZK} @ I_{ZK}$	I_{zk}	I_R	@ V_R	Min	Max	
		Nom(V)	Min(V)	Max(V)	mA	Ω		mA	μA	V			
BZT52C2V4	WX	2.4	2.2	2.6	5	100	600	1.0	50	1.0	-3.5	0	5
BZT52C2V7	W1	2.7	2.5	2.9	5	100	600	1.0	20	1.0	-3.5	0	5
BZT52C3V0	W2	3.0	2.8	3.2	5	95	600	1.0	10	1.0	-3.5	0	5
BZT52C3V3	W3	3.3	3.1	3.5	5	95	600	1.0	5.0	1.0	-3.5	0	5
BZT52C3V6	W4	3.6	3.4	3.8	5	90	600	1.0	5.0	1.0	-3.5	0	5
BZT52C3V9	W5	3.9	3.7	4.1	5	90	600	1.0	3.0	1.0	-3.5	0	5
BZT52C4V3	W6	4.3	4.0	4.6	5	90	600	1.0	3.0	1.0	-3.5	0	5
BZT52C4V7	W7	4.7	4.4	5.0	5	80	500	1.0	3.0	2.0	-3.5	0.2	5
BZT52C5V1	W8	5.1	4.8	5.4	5	60	480	1.0	2.0	2.0	-2.7	1.2	5
BZT52C5V6	W9	5.6	5.2	6.0	5	40	400	1.0	1.0	2.0	-2.0	2.5	5
BZT52C6V2	WA	6.2	5.8	6.6	5	10	150	1.0	3.0	4.0	0.4	3.7	5
BZT52C6V8	WB	6.8	6.4	7.2	5	15	80	1.0	2.0	4.0	1.2	4.5	5
BZT52C7V5	WC	7.5	7.0	7.9	5	15	80	1.0	1.0	5.0	2.5	5.3	5
BZT52C8V2	WD	8.2	7.7	8.7	5	15	80	1.0	0.7	5.0	3.2	6.2	5
BZT52C9V1	WE	9.1	8.5	9.6	5	15	100	1.0	0.5	6.0	3.8	7.0	5
BZT52C10	WF	10	9.4	10.6	5	20	150	1.0	0.2	7.0	4.5	8.0	5
BZT52C11	WG	11	10.4	11.6	5	20	150	1.0	0.1	8.0	5.4	9.0	5
BZT52C12	WH	12	11.4	12.7	5	25	150	1.0	0.1	8.0	6.0	10.0	5
BZT52C13	WI	13	12.4	14.1	5	30	170	1.0	0.1	8.0	7.0	11.0	5
BZT52C15	WJ	15	13.8	15.8	5	30	200	1.0	0.1	10.5	9.2	13.0	5
BZT52C16	WK	16	15.3	17.1	5	40	200	1.0	0.1	11.2	10.4	14.0	5
BZT52C18	WL	18	16.8	19.1	5	45	225	1.0	0.1	12.6	12.4	16.0	5
BZT52C20	WM	20	18.8	21.2	5	55	225	1.0	0.1	14.0	14.4	18.0	5
BZT52C22	WN	22	20.8	23.3	5	55	250	1.0	0.1	15.4	16.4	20.0	5
BZT52C24	WO	24	22.8	25.6	5	70	250	1.0	0.1	16.8	18.4	22.0	5
BZT52C27	WP	27	25.1	28.9	2	80	300	0.5	0.1	18.9	21.4	25.3	2
BZT52C30	WQ	30	28.0	32	2	80	300	0.5	0.1	21.0	24.4	29.4	2
BZT52C33	WR	33	31.0	35	2	80	325	0.5	0.1	23.1	27.4	33.4	2
BZT52C36	WS	36	34.0	38	2	90	350	0.5	0.1	25.2	30.4	37.4	2
BZT52C39	WT	39	37.0	41	2	130	350	0.5	0.1	27.3	33.4	41.2	2
BZT52C43	WU	43	40.0	46	2	100	700	1.0	0.1	32	10.0	12.0	5
BZT52C47	WV	47	44.0	50	2	100	750	1.0	0.1	35	10.0	12.0	5
BZT52C51	WW	51	48.0	54	2	100	750	1.0	0.1	38	10.0	12.0	5

Note:

1. Tested with pulses, period = 5ms, pulse width = 300us.
2. When provided, otherwise, parts are provided with date code only, and type number identifications appears on reel only.
3. $f=1\text{KHz}$.



BZT52C2V4 ~ BZT52C51

RATINGS AND CHARACTERISTIC CURVES

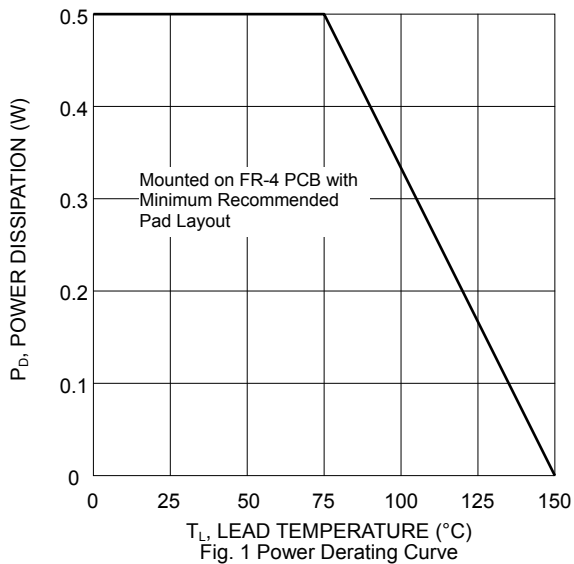

Fig. 1 Power Derating Curve

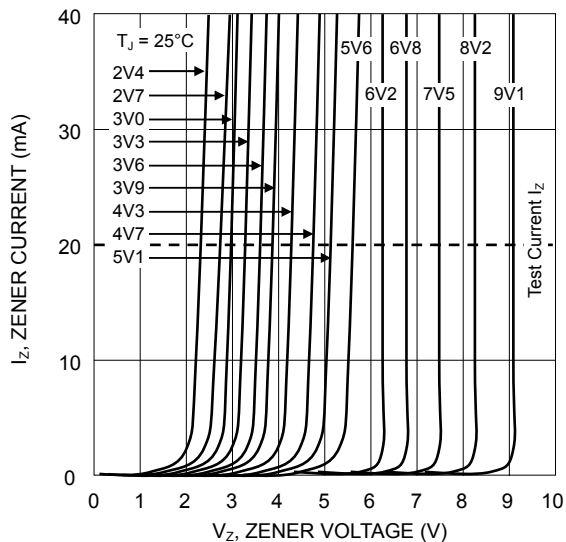

Fig. 2 Zener Breakdown Characteristics

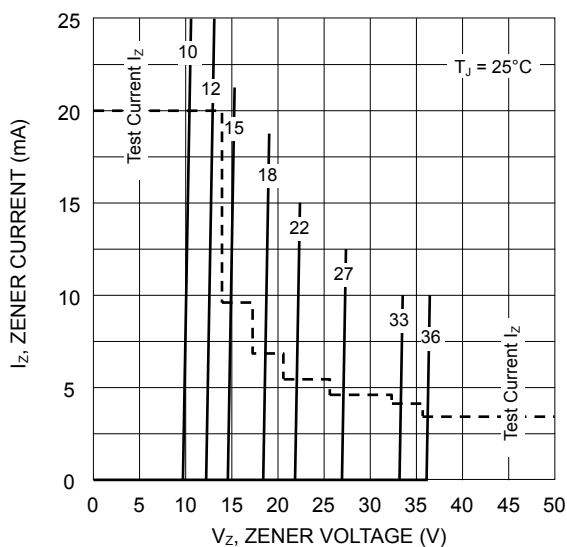

Fig. 3 Zener Breakdown Characteristics

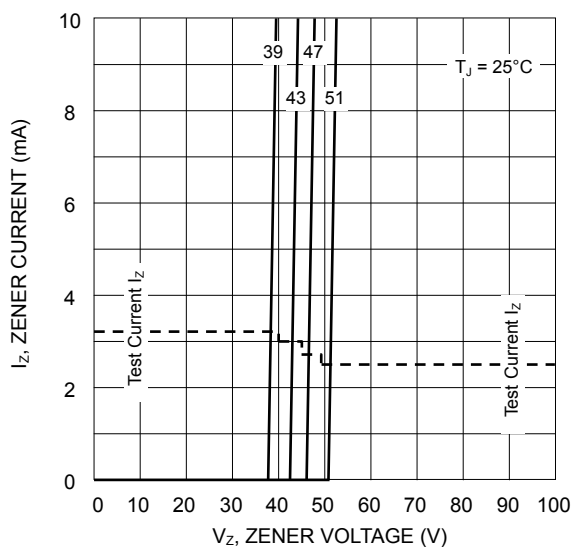

Fig. 4 Zener Breakdown Characteristics

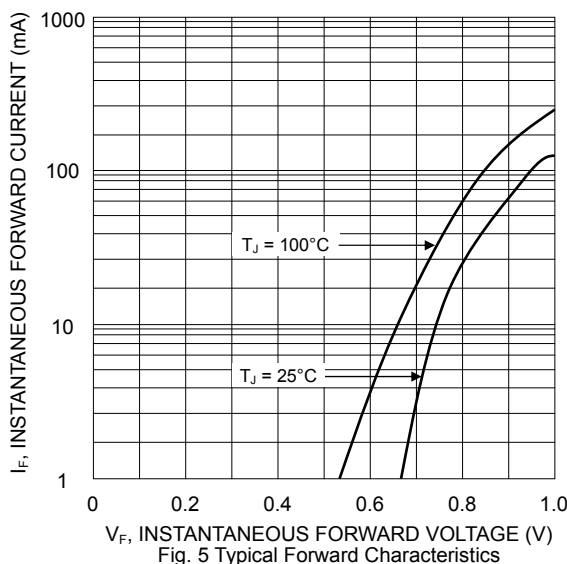

Fig. 5 Typical Forward Characteristics

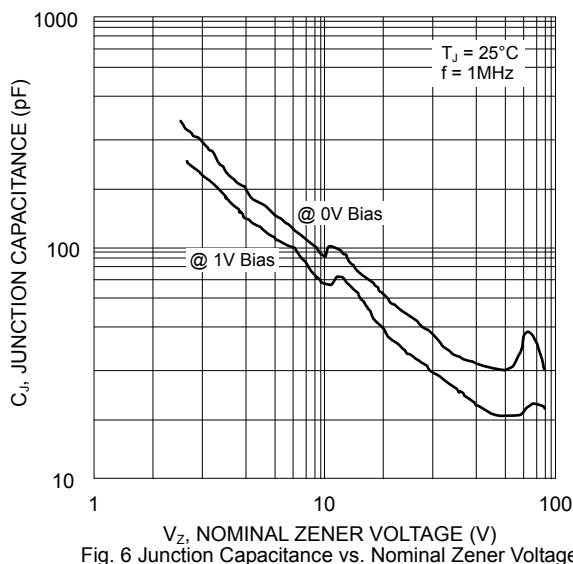

Fig. 6 Junction Capacitance vs. Nominal Zener Voltage